

- (A) Colector drenaje 2"
2" Drainage manifold
- (B) Colector entrada 6"
6" Inlet manifold
- (C) Colector salida 6"
6" Outlet manifold

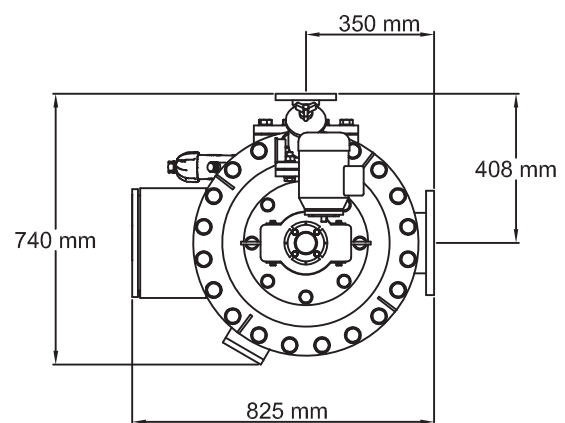

AZUD LUXON LDB 7400/6

SCALE S/E A4 FORMAT	MATERIAL:	RESPONS.: M. Martínez	AZUD
	UNITS: mm.	REVISION: 00	
	FILE: Azud_luxon_LDB_7400-6.dwg	04/05/2012	